

CONF-970201--3

APPLICATION OF RAMAN SPECTROSCOPY TO HIGH-TEMPERATURE

ANALYTICAL MEASUREMENTS

J. P. Young,<sup>1</sup> Sheng Dai,<sup>2</sup> Yuan Lee,<sup>1</sup> and Haiming Xiao<sup>1</sup>

<sup>1</sup>Chemical & Analytical Sciences Division  
<sup>2</sup>Chemical Technology Division  
Oak Ridge National Laboratory  
P.O. Box 2008  
Oak Ridge, TN 37831-6142

RECEIVED  
DEC 19 1996  
OSTI

Abstract

There are numerous analytical applications of scatter-emission and/or absorption spectroscopy applied to liquids and solids in the temperature range of 0 to 350°C. In this paper an all-silica fiberoptic probe is described which is useful for spectral analyses from 0 to 1600 K and can be used in harsh chemical environments. The probe has been used for Raman spectral analyses of many molten salt and solid material systems to 1000°C. It has applications for such studies at higher temperature ranges. The instrumentation required along with the demonstrated and proposed applications of the all-silica probe are presented and discussed.

"The submitted manuscript has been authored by a contractor of the U.S. Government under contract No. DE-AC05-96OR22464. Accordingly, the U.S. Government retains a nonexclusive, royalty-free license to publish or reproduce the published form of this contribution, or allow others to do so, for U.S. Government purposes."

J. P. Young et al

MASTER

DISTRIBUTION OF THIS DOCUMENT IS UNLIMITED

Research sponsored by the Strategic Environmental Research and Development Plan (SERDP), U.S. Department of Defense and the Office of Industrial Technology and Laboratory Technology Division of the U.S. Department of Energy under contract DE-AC05-96OR22464 with Oak Ridge National Laboratory, managed by Lockheed Martin Energy Research Corporation.

DISTRIBUTION OF THIS DOCUMENT IS UNLIMITED

DISTRIBUTION OF THIS DOCUMENT IS UNLIMITED

## DISCLAIMER

This report was prepared as an account of work sponsored by an agency of the United States Government. Neither the United States Government nor any agency thereof, nor any of their employees, make any warranty, express or implied, or assumes any legal liability or responsibility for the accuracy, completeness, or usefulness of any information, apparatus, product, or process disclosed, or represents that its use would not infringe privately owned rights. Reference herein to any specific commercial product, process, or service by trade name, trademark, manufacturer, or otherwise does not necessarily constitute or imply its endorsement, recommendation, or favoring by the United States Government or any agency thereof. The views and opinions of authors expressed herein do not necessarily state or reflect those of the United States Government or any agency thereof.

**DISCLAIMER**

**Portions of this document may be illegible in electronic image products. Images are produced from the best available original document.**

## Introduction

There are many kinds of scatter-emission spectroscopies that are of value for analytical measurements. Fluorescence, reflectance, arc or spark emission are descriptors for some of these. Raman scatter spectroscopy is also quite a useful technique for analytical measurements.

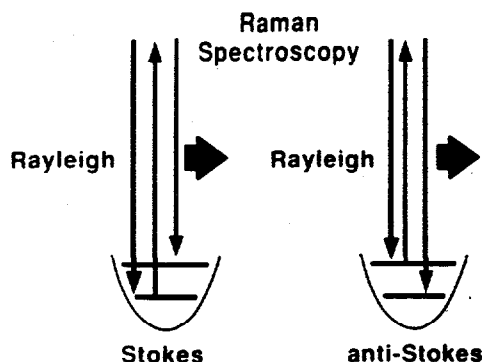

Figure 1. Basis for Raman spectroscopy.

In Figure 1, we give a simplified explanation of the Raman effect. If one shines monochromatic light into a sample, light may be absorbed, exciting the sample to some virtual state. We know from experience that almost all of the light is re-emitted in the same wavelength range. This is called Rayleigh or Meinel scattering and is designated in the figure by the arrows in both examples that point up and down from the same lower energy state. A very small percentage (the order of 10<sup>-4</sup>%) of the monochromatic light is re-emitted leaving the sample at a vibrationally-excited state. Thus, this light is at a distinctly lower energy compared to the exciting radiation. This is called a Stokes shift and is represented in the left-hand example by an arrow descending to a more energetic vibrational state. If the sample is not at a temperature of absolute zero, some of this vibrationally excited state will be thermally populated. That portion of the sample still absorbs and re-emits exciting radiation as Rayleigh scattered light, but a small percentage of the exciting light is re-emitted as the sample relaxes to the lower vibrational state. The energy of this light is of higher energy and is called an anti-Stokes shift, depicted in the example to the right. Notice that the energy separation of the Stokes or anti-Stokes shifted emission from that of the exciting radiation is the same, and expressed in  $\Delta\text{cm}^{-1}$ . The intensity of either shifted emission is a function of the population of the vibrational energy states; therefore, the ratio of the intensity of Stokes to anti-Stokes signal varies with absolute temperature. We will come back to this point later.

From the above description it is apparent that the Raman shifted emission will be weak. It can be quite useful, however, for the determination and identification of components that are present in the percent or more range in samples, and it is used for analytical determinations in this concentration range.

There are a number of commercial instruments that have been developed to carry out Raman spectral studies. The Raman signal can be easily detected by fiberoptic devices, so many of these instruments have fiberoptic capabilities. Fiberoptic Raman probes consist of a fiber that directs an exciting beam of light, from a laser, onto or into a sample. The back-scattered light is picked up by one or more fibers and directed to a spectrometer for detection. Generally, the head of the probe is held together by epoxy resins. Such a design is not useful at temperatures above the decomposition temperature of the resin, or in samples that attack the resin.

### All-Silica Fiberoptic Probe

We have developed an all-silica fiberoptic probe that circumvents the above limitations<sup>1</sup> and is shown in Figure 2. The construction of this fiberoptic probe makes it particularly applicable to

in-line process sensing. The probe is constructed by enclosing two or more silica optical fibers inside a silica tube.

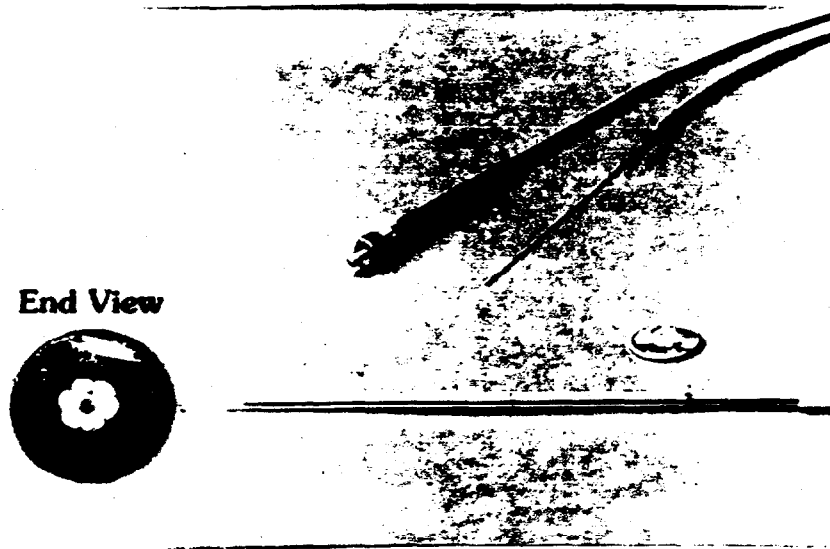

Figure 2. All-silica fiberoptic probe; enlarged view of the probe end.

During fabrication the tube is maintained under reduced pressure. After thermally fusing the optical fibers and the tube together, the end is cut and polished leaving, essentially, a silica rod that maintains the individual characteristics of the fibers of which it is composed. An enlarged view of the probe head is shown in the figure. Note that it is a 1x6 arrangement; the exciting fiber is in the center surrounded by six collection fibers. At the other end of the probe, the six fibers are assembled in a linear array in a connector that can be coupled to a spectrometer. Since the probe head contains only silica it has the chemical and physical properties of a silica rod.

### Layout of Raman Spectroscopic Determination

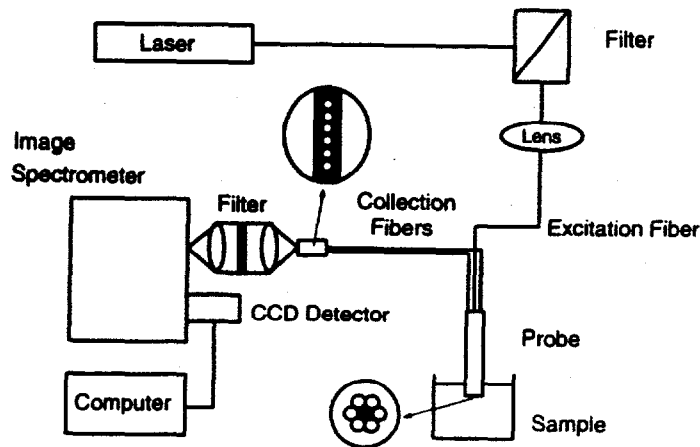

Figure 3. Laboratory instrumentation for Raman studies with the fiberoptic probe.

The design of the laboratory instrumentation we use is typical of most and is shown in Figure 3. Light from a laser is directed through a narrow band-pass filter, to assure monochromatic excitation, and focused into the exciting fiber of the probe. Scattered light from the sample is collected by the six fibers in the probe and directed through a filter that blocks the excitation wavelength. The collected light is focused onto a vertical slit of a monochromator and detected by a charge coupled device (CCD) detector. The spectrophotometric measurement is controlled by a computer.

With our all-silica probe and the above experimental set-up we have carried out Raman spectral studies of a number of molten salts at elevated temperatures. Originally the probe was developed to undertake Raman spectral studies of the  $\text{MgCl}_4^{2-}$  ion in molten  $\text{NaCl-KCl-MgCl}_2\text{-CaCl}_2$  in the temperature range of  $700^\circ$  to  $800^\circ\text{C}$ . The resultant spectrum<sup>1</sup> of  $\text{MgCl}_4^{2-}$  is shown in Figure 4.

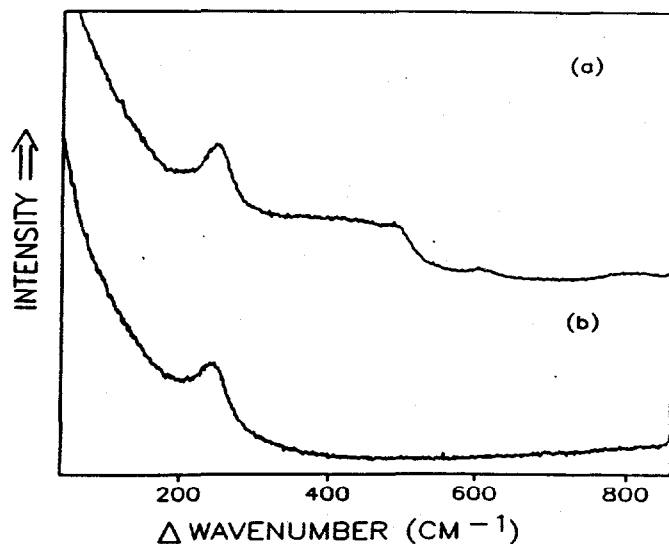

Figure 4. Raman spectra of  $\text{MgCl}_4^{2-}$  in molten  $\text{NaCl-KCl-CaCl}_2\text{-MgCl}_2$  at  $720^\circ\text{C}$ .  
(a) Recorded by the use of the fiberoptic probe;  
(b) Recorded by conventional transmission method.

The spectrum obtained with our all-silica fiberoptic probe is shown as spectrum (a). This is comparable to a Raman spectrum of the same melt obtained by the normal technique (b) where the melt is held in a silica cell and the Raman scatter emission is observed at right angles to the laser exciting beam. The  $\text{SiO}_2$  in optical fibers also generates a Raman signal. This is seen in (a) as the broad peak underlying the  $\text{MgCl}_4^{2-}$  peak along with several additional peaks near  $600$  and  $800 \text{ cm}^{-1}$ . If the silica background is subtracted from the spectrum, spectrum (a) and (b) are identical.

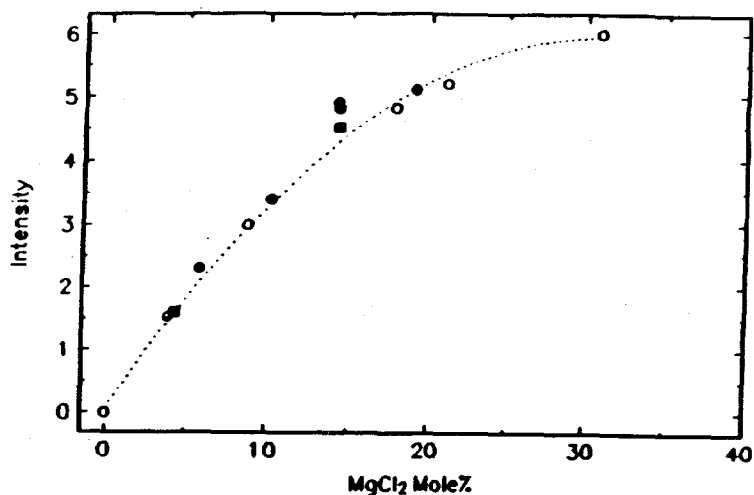

Figure 5. Calibration curve relating  $\text{MgCl}_4^{2-}$  concentration to Raman peak intensity in molten  $\text{NaCl-KCl-CaCl}_2\text{-MgCl}_2$  at  $720^\circ\text{C}$ . Solid circles determined via conventional Raman technique; open circles and squares determined using fiberoptic probes.

Quantitative determinations via Raman spectrometry are sometimes difficult to accomplish. The intensity of a Raman signal is controlled by many parameters: concentration of the species in question, laser intensity, sample scatter, sample clarity, etc. In the past, the Raman signal arising from the species in question is normalized to some stable Raman signal in the sample or a reference material is added for normalization.<sup>2</sup> In our case and in process streams in general, the above possibilities are not practical. We have developed a method wherein a particular location on the Rayleigh scatter curve is used as the normalization point.<sup>3</sup> In Figure 5 we show the calibration curve for  $\text{MgCl}_4^{2-}$  in the molten chloride solution derived in this manner. It can be seen that the calibration over the range of 0 to 30 mole %  $\text{MgCl}_2$  is not linear. Later Raman studies with molten mixtures of  $\text{MgCl}_2$  and  $\text{KCl}$ , carried out with the all-silica fiberoptic probe, revealed there are two species present in alkali chloride-magnesium chloride melts,  $\text{MgCl}_4^{2-}$  and  $\text{Mg}_2\text{Cl}_7^{3-}$ .<sup>3,4</sup> The latter species is more prevalent at high  $\text{MgCl}_2$  concentration and is most likely responsible for the nonlinear calibration curve. Spectra of the pure species derived from this study are shown in Figure 6.

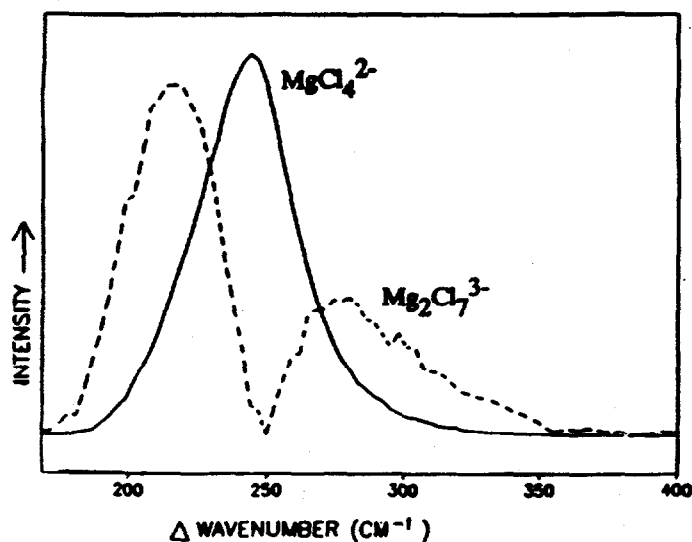

Figure 6. Extracted Raman spectra for  $\text{MgCl}_4^{2-}$  and  $\text{Mg}_2\text{Cl}_7^{3-}$ .

There are other aspects of high temperature fiberoptic Raman spectroscopy that can be advantageous. In Figure 1, we discussed anti-Stokes Raman signals; in Figure 4, we show the silica (Stokes) background signal that lies beneath the  $\text{MgCl}_4^{2-}$  Stokes signal. At high temperatures, anti-Stokes signals increase in intensity because the excited vibrational levels (Figure 1) are more populated. Most of the fiberoptic probe, however, is at room temperature in the above example; i.e., only a small part of the probe is actually heated. An anti-Stokes Raman spectrum therefore yields an enhanced molten salt spectrum and a diminished silica background.<sup>5</sup> This aspect is shown in Figure 7; compare, for example, the Stokes and anti-Stokes signals for  $\text{MgCl}_2 \cdot 2$  and silica in the spectral pairs presented.

Using the all-silica fiberoptic probe we have studied a number of molten salt systems. In Figure 8, we show the Raman spectrum of a mixture<sup>6</sup> of  $\text{AlCl}_x\text{F}_{4-x}^-$  species in molten  $\text{NaF-AlCl}_3$  at  $750^\circ\text{C}$ . The Raman spectrum of  $\text{CO}_3^{2-}$  in molten  $\text{Li}_2\text{CO}_3\text{-Na}_2\text{CO}_3$  at  $520^\circ\text{C}$  is presented in Figure 9. The probe was chemically attacked in this last melt, but it was still possible to collect the Raman signal. The probe has also been used to collect Raman spectra in molten poly (ethylene terephthalate), PET, at  $280^\circ\text{C}$ .

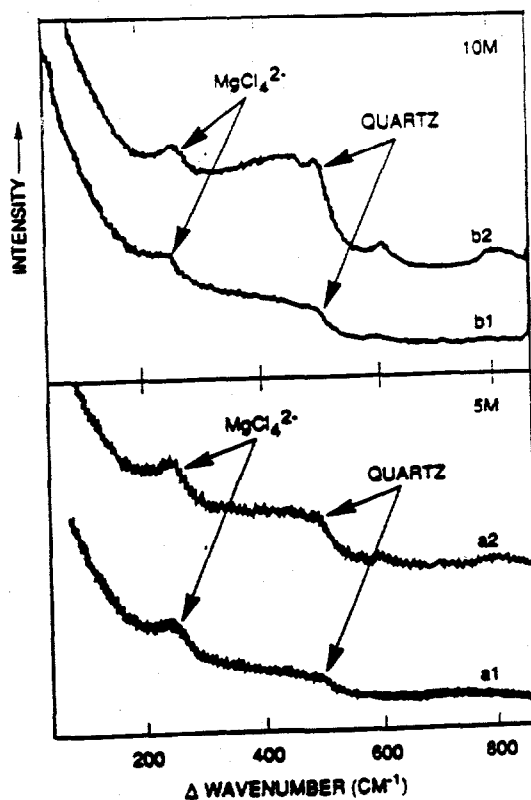

Figure 7. Spectra *a1* and *b1* are anti-Stokes Raman spectra recorded for a four-component melt at  $720^\circ\text{C}$  via 5- and 10-m optic fibers, respectively, while spectra *a2* and *b2* are the corresponding Stokes Raman spectra.



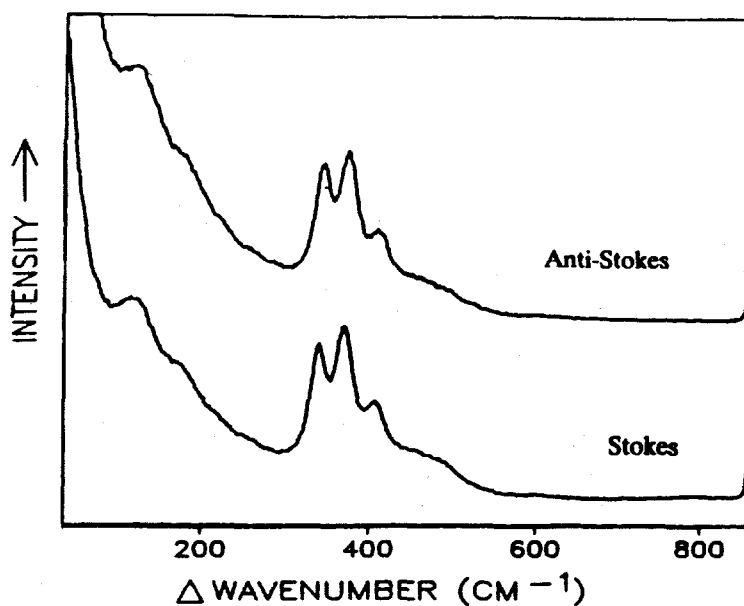

Figure 8. Raman spectra of  $\text{AlCl}_x\text{F}_{4-x}$  species in molten  $\text{NaF-AlCl}_3$  at  $750^\circ\text{C}$ .

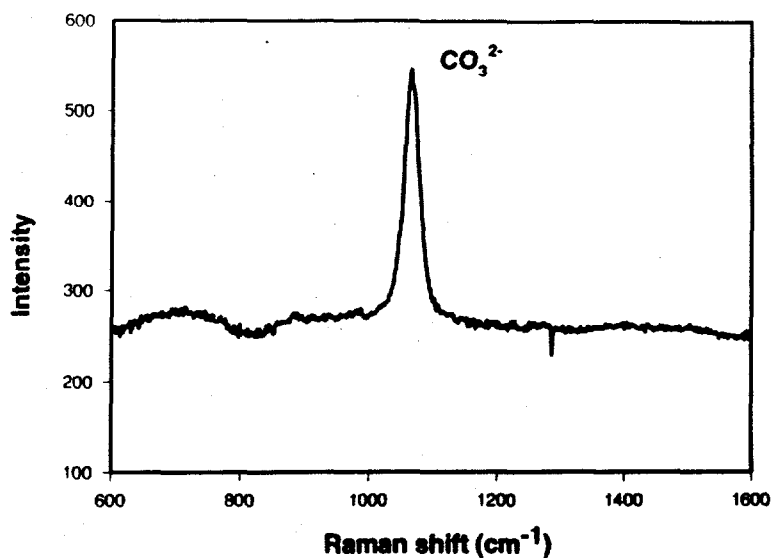

Figure 9. Raman spectrum of  $\text{CO}_3^{2-}$  in molten  $\text{Li}_2\text{CO}_3\text{-Na}_2\text{CO}_3$  at  $520^\circ\text{C}$ .

### Temperature Measurements

There are other applications that can be made of Raman spectral measurements at high temperature. On the basis of fundamental Raman spectroscopy theory, the Stokes/anti-Stokes ratio is a function of temperature and the relationship is given as,<sup>7</sup>

$$S/AS = \frac{(\bar{\nu}_o - \bar{\nu}_k)^4}{(\bar{\nu}_o + \bar{\nu}_k)^4} \exp \{hc\bar{\nu}_k/kT\}$$

for the ratio of the [S] Stokes ( $\nu_o - \nu_k$ ) to the [AS] anti-Stokes ( $\nu_o + \nu_k$ ) line intensities. Here  $\nu_o$  and  $\nu_k$  are the frequencies in  $\text{cm}^{-1}$  of the exciting light and the scattered Raman light, respectively;  $h$  is Planck's constant;  $k$  is Boltzmann's constant;  $T$  is temperature. Several things are of note. The temperature measurement is based on first principles; no calibration is required. The sensitivity of the measurement is a direct function of the Stokes (or anti-Stokes) shift; the greater the  $\Delta\text{cm}^{-1}$  of the Raman signal, the more sensitive the measurement. We made use of this phenomenon to measure temperature in the range of  $300^\circ$  to  $1000^\circ\text{C}$  by Raman measurements of diamond in air.<sup>8</sup> We were limited in that experiment by the oxidation of diamond. Diamond exhibits a very sharp, singular, intense Raman peak at  $1332\text{ cm}^{-1}$  and is ideally suited for this measurement. It should be pointed out, however, that both the position and width of the peak is somewhat influenced by temperature.<sup>8</sup>

With proper protection, diamond would be suitable as a temperature probe at temperatures up to the point at which it becomes graphite, approximately  $2200^\circ\text{C}$ .

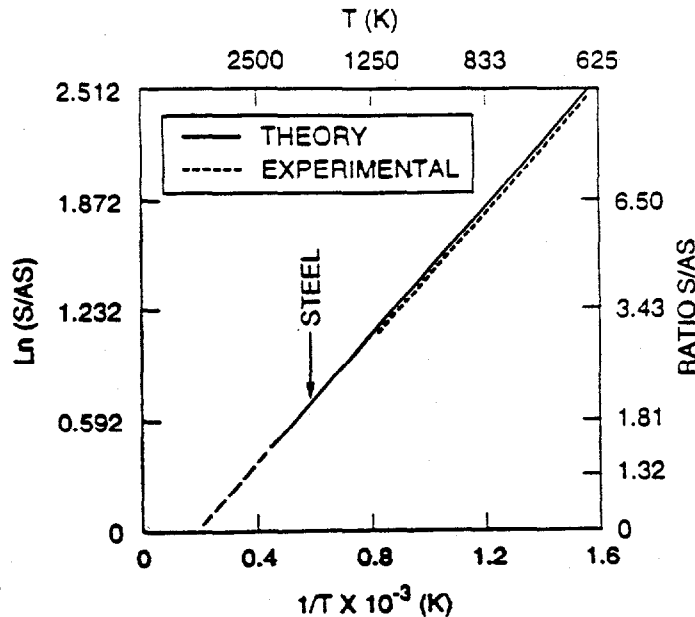

Figure 10. Idealized Stokes/anti-Stokes ratio of a diamond as a function of temperature.

An idealized comparison of our experimental data and the usefulness of this technique is shown in Figure 10. The system would be ideal for temperature measurement in the region of  $1000^\circ$  to  $2000^\circ\text{C}$  as the ratios could be measured with good precision. One could envision making very accurate temperature measurements of molten metals, such as steel or titanium, by using a protected diamond chip viewed by a single or multiple fibered Raman probe. The measurement is made with insulating materials; no conductors are present in the measurement location. This technique is therefore not affected by electric or magnetic fields, a definite advantage in electric furnaces.

## References

1. Sheng Dai, J. P. Young, G. M. Begun, J. E. Coffield, and G. Mamantov, "Measurement of Molten Salt Raman Spectra by the Use of Fiber Optics," Microchim. Acta, 108 (1992) 261.
2. D. P. Strommen and K. Nakamoto, Laboratory Raman Spectroscopy (John Wiley & Sons, New York, 1984), p. 11.
3. Sheng Dai, G. Mamantov, J. E. Coffield, G. M. Begun, and J. P. Young, "Accurate Procedure for Determining the Calibration Curve of High-Temperature Molten Salt Systems via Raman Spectroscopy," Appl. Spectrosc., 47 (1993) 1286.
4. Sheng Dai, G. M. Begun, J. P. Young, and G. Mamantov, "Application of Chemometric Methods in Raman Spectroscopic Studies of Molten Salt System Containing  $MgCl_2$ -KCl: Experimental Evidence for Existence of  $Mg_2Cl_7^{3-}$  Dimer and Its Raman Spectrum," J. of Raman Spectrosc., 26 (1995) 929.
5. Sheng Dai, J. E. Coffield, G. Mamantov, and J. P. Young, "Reduction of Quartz Fiber Raman Backgrounds in High Temperature Fiberoptic Raman Spectroscopy via the Measurement of Anti-Stokes Raman Spectra," Appl. Spectrosc., 48 (1994) 766.
6. B. Gilbert, S. D. Williams, and G. Mamantov, Inorg. Chem., 27 (1988) 2359.
7. D. A. Long, Raman Spectroscopy (McGraw Hill, London, 1977), p. 84.
8. Sheng Dai, J. P. Young, G. M. Begun, and Gleb Mamantov, "Temperature Measurement by Observation of the Raman Spectrum of Diamond," Appl. Spectrosc., 46 (1992) 375.